

FiREBiRD



Bio-Tec

Wood Gasification Boiler



FiREBiRD

Contents

- I. Understanding Wood Gasification Technology**
- II. The Firebird Bio-Tec Wood Gasification Boiler**
- III. User Operation**
- IV. Installation & commissioning**
- V. Maintenance**
- VI. Sales & Marketing information
(Pricing, components, literature)**



Part I

Understanding Wood Gasification Technology



Background

- **Wood gasification boilers have evolved over the past decade and today can ensure a very efficient and clean combustion of wood**
- **Characteristics**
 - Efficiencies between 85% and 90%
 - Cheap fuel source (free if you have you own timber)
 - Carbon-neutral heating
 - low emissions – the cleanest form of wood burning
 - ash waste ensure minimal of cleaning

How it works

- Dried wood is loaded and burnt in the upper chamber
- Gases released from the combusting wood are drawn down to the lower chamber by extractor fan (located at the flue outlet)
- These gases are mixed with a regulated supply of oxygen (secondary air) to create a complete oxidation process

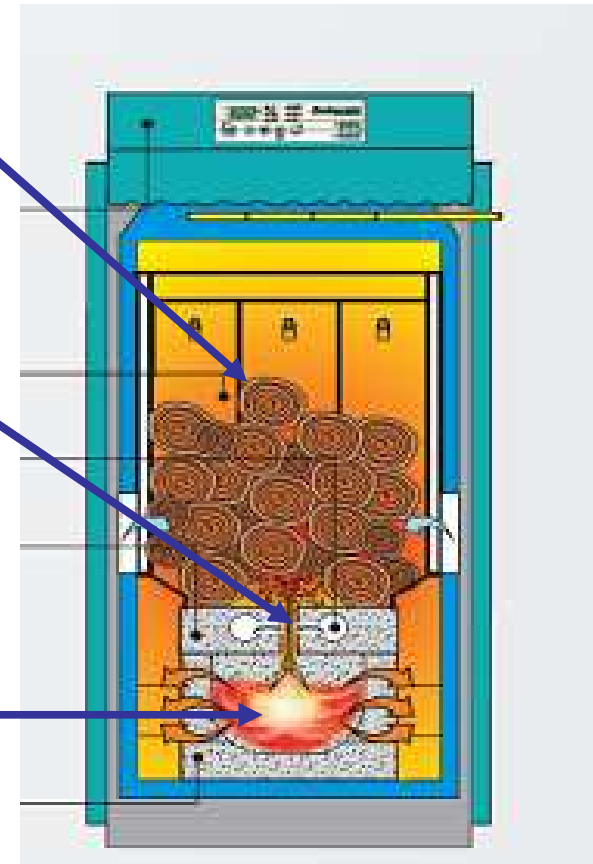

How does wood burn ?



There are essentially 3 stages involved in burning wood...

- I. When the wood is first heated most of the energy is used to remove the moisture from it
- II. As the wood heats up (100°C to 300°C) it starts to smoke. Smoke is a cloud of combustible gases (CO₂, CO, H, C_xH_y, etc.) and tar droplets
 - Smoke will burn if the temperature is high enough and enough combustion air is supplied.
 - If the smoke does not burn it will flow into the chimney where it will either condense as creosote or go outside as air pollution (waste)
- III. As the fire progresses and most of the gases and tars have vaporized out of the wood and charcoal remains. Charcoal is almost 100% carbon and burns with a red glow and very little flame or smoke

Gasification v. Conv. Wood Boiler

- Forced draft (fan)
- Automatic primary/secondary air valves
- Flue gas monitoring
- Fast hot burn ($>1200^{\circ}\text{C}$)
- No tar or charcoal build up
- Single fill of wood per day
- Uses approx. 40% less wood
- Natural draft
- Manual primary/secondary air valves
- No monitoring gases
- Slow cool burn (800°C)
- Tar/charcoal build up
- Must burn when heating is required
- Uses more wood



Types of Fuel



- **As the name implies, wood gasification boilers can only be used to burn wood. Coal, peat, refuse, etc. can not be used in the Bio-Tec boiler**
- **Best woods**
 - Hard woods like Ash, Oak & Beech enable a longer burn time
 - Spruce, etc. burn quicker and create more ash waste
- **What is the energy content of wood?**
 - it depends mainly on the moisture content. Bone dry wood of any species has about the same calorific value of *ca.* 19 MJ/Kg
 - Dried wood ~ 14.5 MJ/Kg @ 20% moisture
 - Wood pellets ~ 18.0 MJ/Kg @ <10% moisture
 - Kerosene ~ 43.1 MJ/Kg or 34.9 MJ/litre

Fuel Cost Comparison



- **Kerosene delivers about 3 times more heat energy per Kg than dried wood (43.1 MJ/Kg v. 14.5 MJ/Kg)**
or 1 litre of Kerosene = ~ 2.5 Kg of dried wood
- **Sample fuel costs**
 - Kerosene €0.90 / litre = €1.11 / Kg
 - Dried wood €150 / Tonne = €0.15 / Kg
- **Compare annual heating costs**
 - 2000 litres of Kerosene = €1,800
 - Equivalent to 5000 Kg of wood = € 750
 - Annual SAVINGS = €1,050

The impact of moisture



- The less moisture the better the heating energy of wood as the below chart demonstrates:

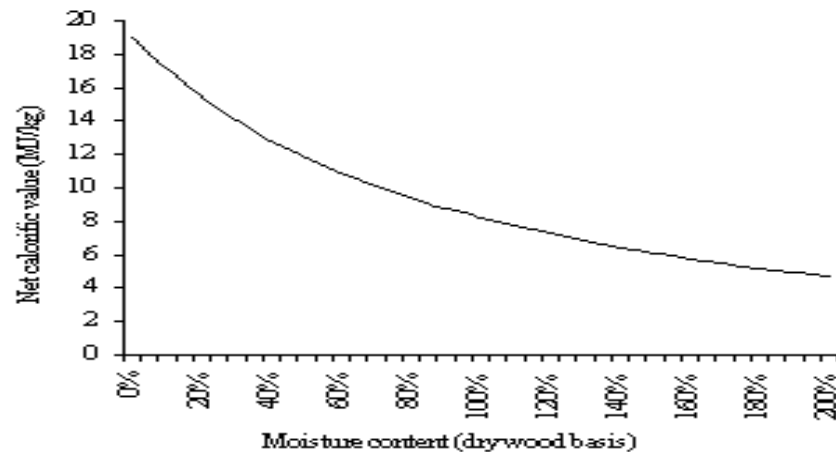

- A high moisture content will cause a buildup of tar and soot in the chimney and the increased condensation occurring inside the boiler will reduce its lifespan

The impact of moisture (cont.)

- **The moisture content of wood fuels is influenced by the climatic conditions, the time of year, tree species, the part of tree stem and by storage phase.**
 - Freshly cut Hardwoods 40% and 50%
 - Freshly cut Softwoods 50% and 60%.
- **One summer seasoning reduces the moisture content by 10 to 15%. For the Irish climate two years drying is recommended**
- **On a wood gasification boiler moisture content should be 20% or less; and never over 25%**
- **Moisture measuring devices are available, e.g. Testo 606 series**



Tips for drying wood



The best way to dry your wood is to

- **split it first**
 - Split wood has less bark and will therefore dry faster
- **stack it at right angles to the prevailing winds**
 - To allow air to circulate around the wood
- **make sure it is covered and off the ground**
 - keeps moisture at bay
 - The best drying place is an open sided shed. Old pallets could be used to keep wood off the ground

If you dry your wood inside, allow for adequate ventilation.

Note that drying wood gives off a lot of water which could create a dampness problem

Part II

Firebird **Bio-Tec**

Wood Gasification Boiler



Main Components

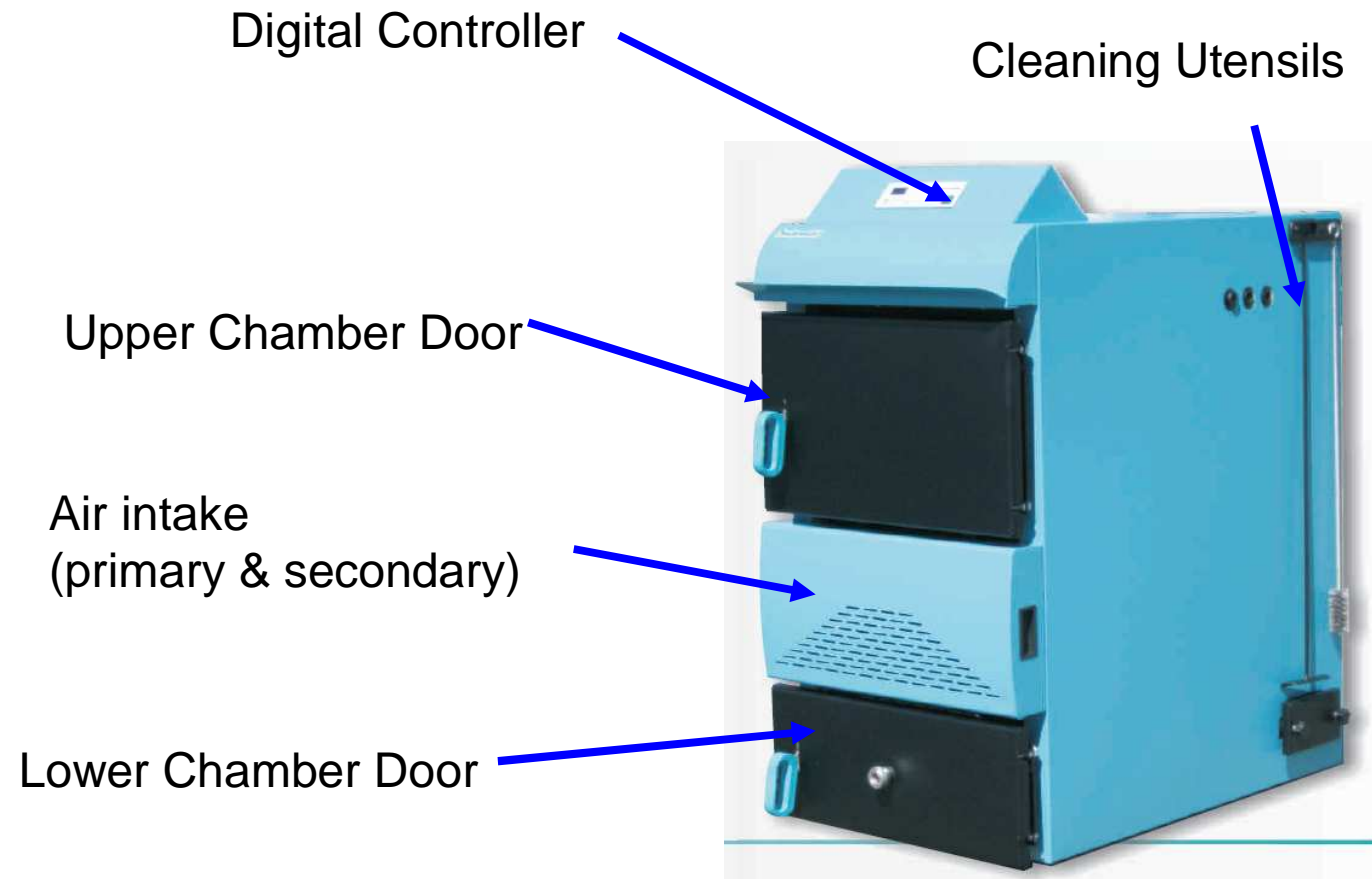

Cross Sectional View

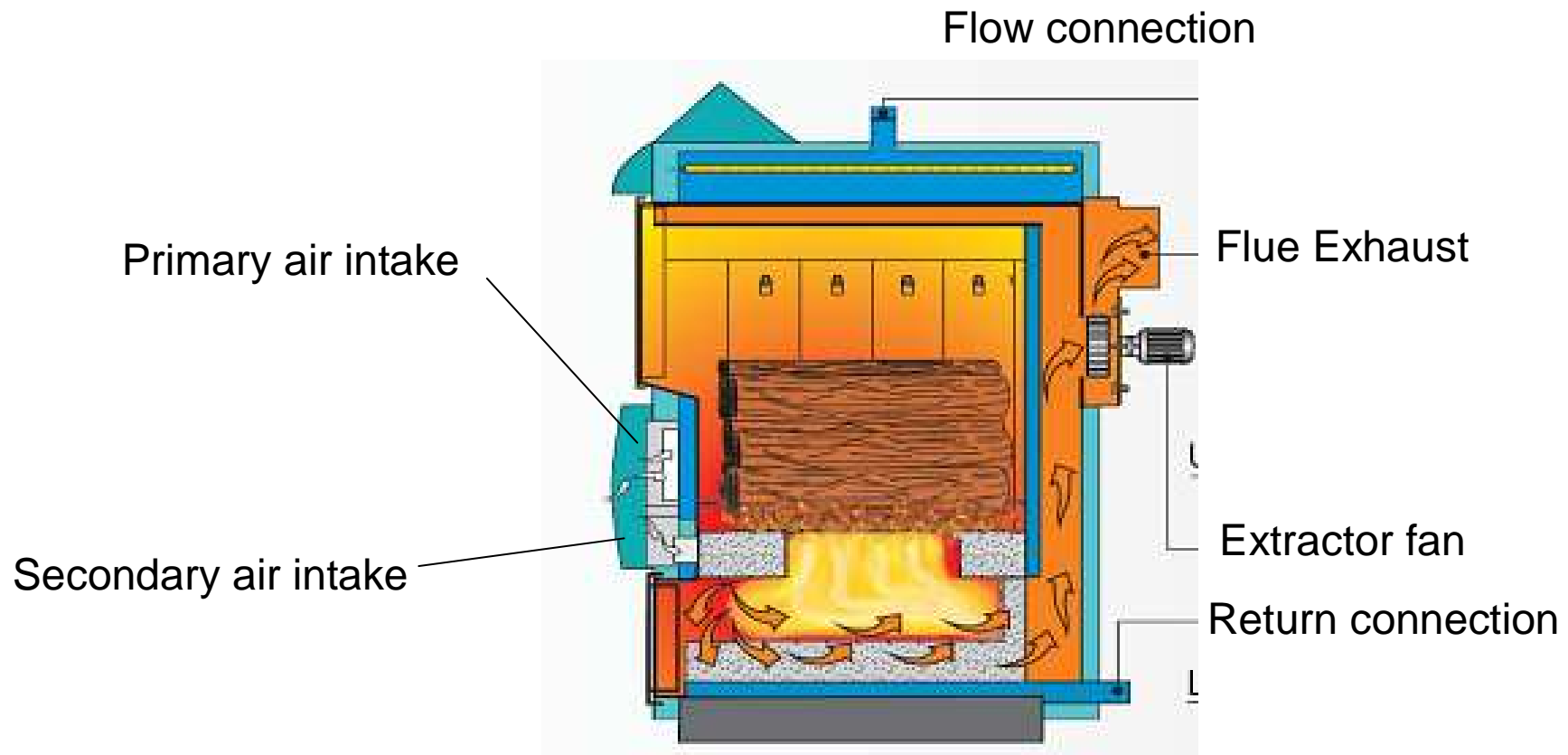

Digital Controller

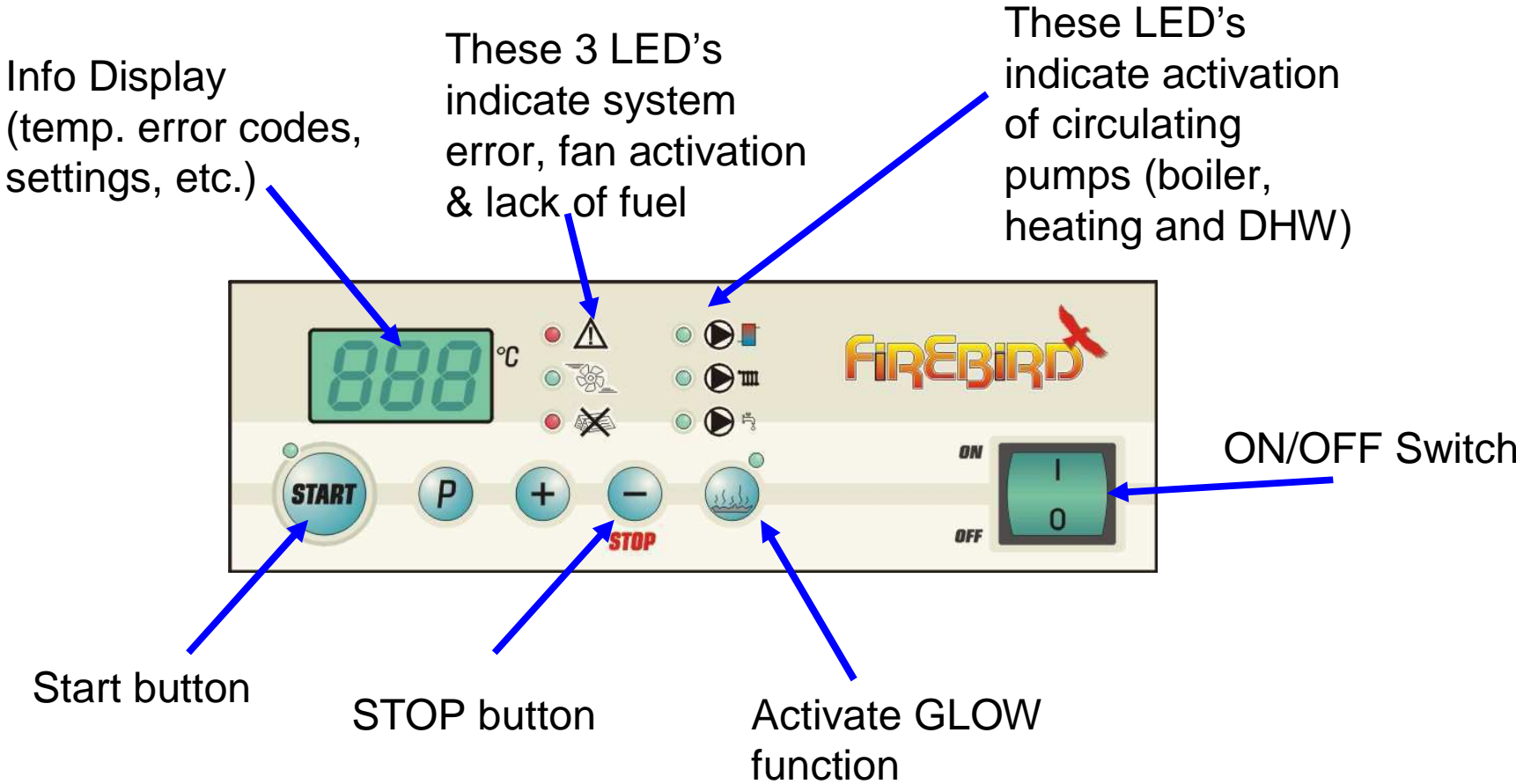

Key Specifications

| <i>Specification</i> | <i>units</i> | <i>Value</i> |
|-------------------------------------|---------------------|--------------------------|
| Output | kW | 35 |
| Outer Dimensions (W x D x H) | mm | 720 x 1200 x 1300 |
| Boiler Weight | Kg | 515 |
| Boiler Water Content | litre | 96 |
| Max Operating Pressure | bar | 2.5 |
| Max Operating Temperature | °C | 90 |
| Flue gas temp | °C | 190 |
| Recommended flue draft | Pa | 18 |
| Max length of wood permitted | mm | 550 |
| Wood storage volume | litre | 132 |

Advantages of Bio-Tec

- **Built to the highest manufacturing standards**
- **Robust build**
- **Easy to clean**
- **State-of-the-art controller regulates the complete combustion process and ensures optimal efficiency**

Part III

User Operation



Starting the boiler

- 1. Make sure that both chambers are reasonably clean (see maintenance instructions)**
- 2. Build a small 'kindling fire' with paper/firelighter and some well-dried kindling**
- 3. Close the lower chamber door**
- 4. Turn on the MAIN SWITCH power switch and push the START button. The fan will start up and the LED light next to the start button will begin to flicker.**
- 5. Light the kindling fire and close the upper door.**
- 6. When a good glow has been created open the upper chamber door and load with the desired amount of timber**
- 7. Close the upper chamber door and again push the button START. The boiler is now in gasification mode**

Maintaining the Fire

- Typically when the chamber is fully loaded the fire will last for about 5 hours
- When the amount of wood inside the upper chamber runs low an LED will light up on the controller
- The upper chamber should be refilled if you want to continue the heating process
- If you don't need any additional heat but want to maintain fire inside the chamber select the GLOW function. The boiler controller will maintain a glow fire for up to 12 hours. While the glow exists wood can be reloaded without having to go thru the start-up process



Switching off the Boiler

- **Press the STOP switch and wait until the boiler(?) temperature drops below 65 C and the glow inside the combustion chamber disappears**
- **Then switch off the main boiler switch (I/O)**

Error Codes !

If a problem occurs during the operation of the Bio-Tec boiler the error LED (triangle with ! inside) will light up and the relevant error code will appear on the LCD display

- E1 Boiler sensor error**
- E2 Flue gases sensor error**
- E3 Error with sensor for first accumulator tank upper**
- E4 Error on the lower sensor of the last accumulator tank**
- E5 Sensor error DHW**
- E6 Error with room thermostat sensor**

Part IV

System Set-up



Schematic Diagram (Open vented)

Scheme 1. - Open central heating system

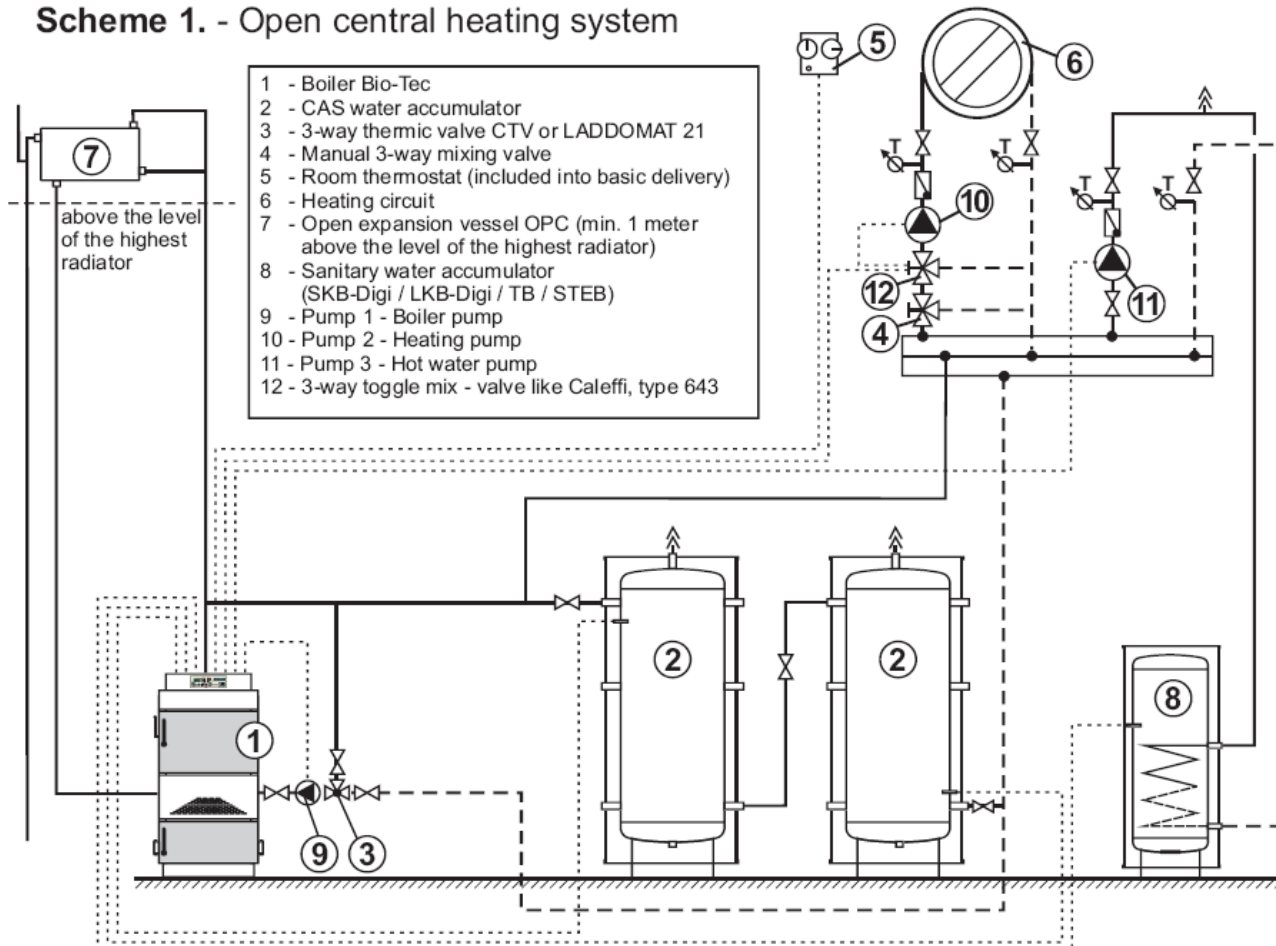

Schematic Diagram (Unvented)

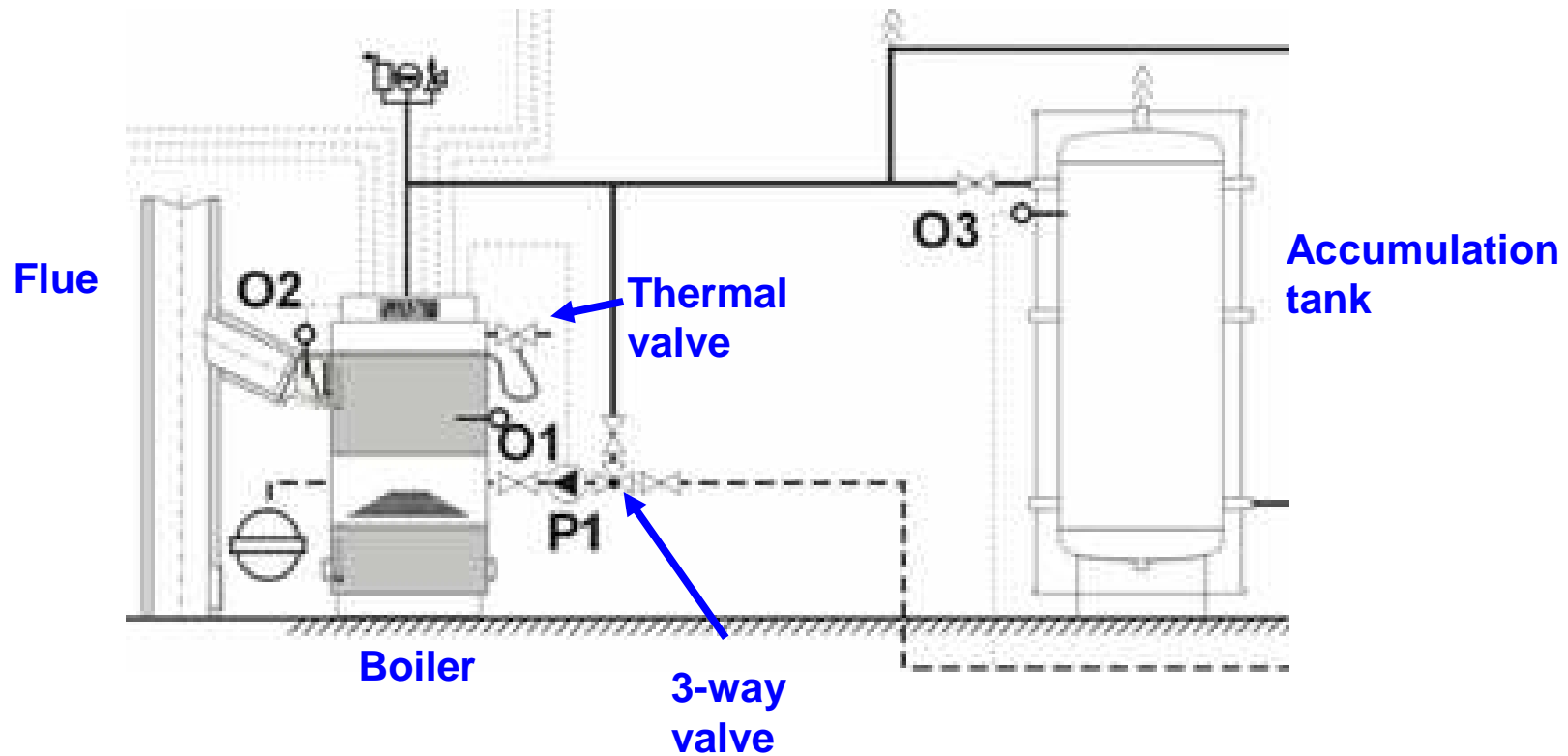

SENSORS

O1 Boiler Temp. Sensor

O2 Flue Gas Temp. Sensor

O3 Accumulator Tank Upper Temp. Sensor

Schematic Diagram (Unvented)

Scheme 2. - Closed central heating system

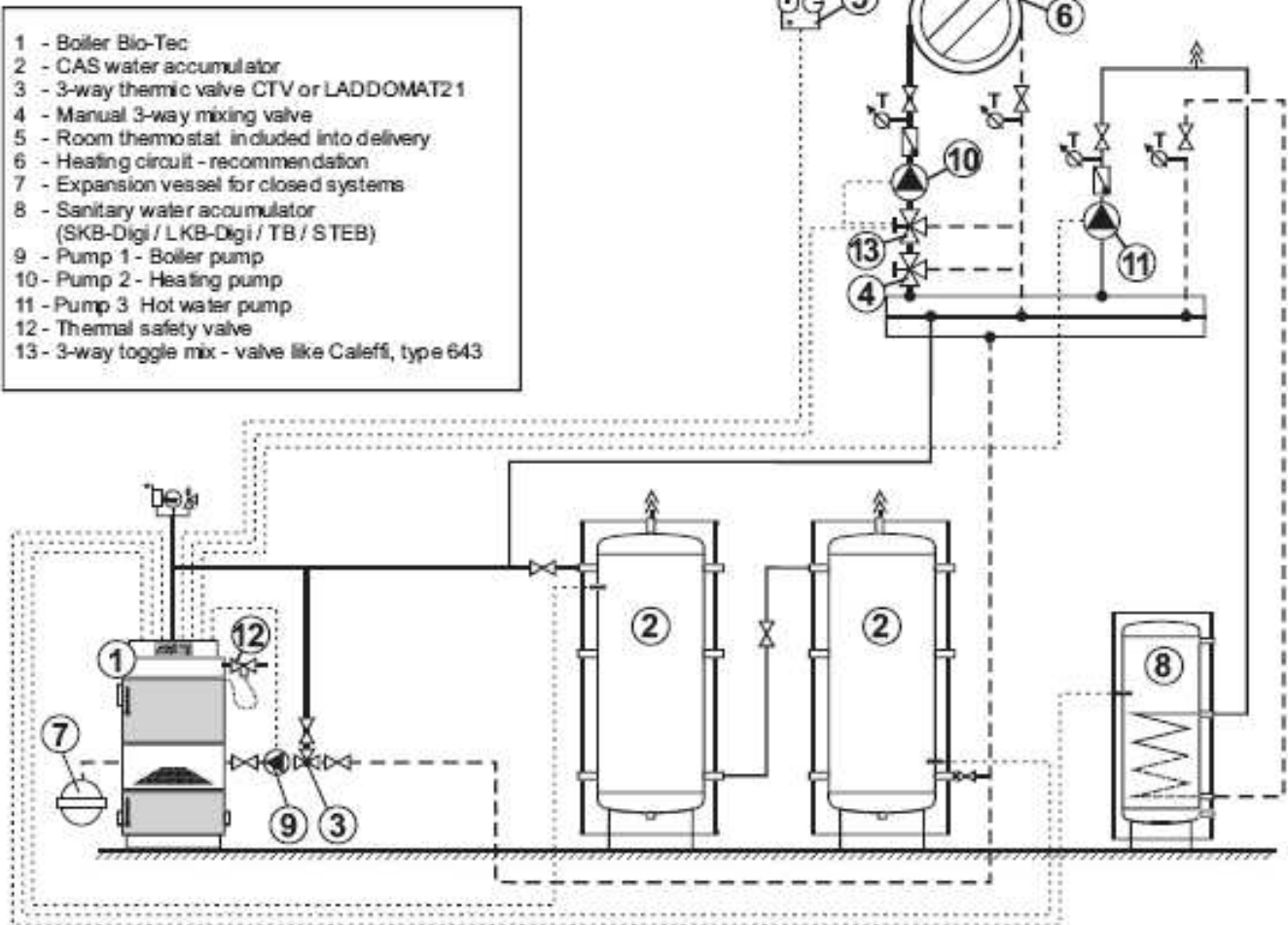

Key Considerations

- Location
 - Due to its size the Bio-Tec should not be installed inside a house or outdoors; the ideal location would be a garage or suitable outbuilding
 - ventilation of the room should be in line with the manufacturer's guidelines
 - good thermal draught in the room
 - unrestricted access to the boiler from where the wood is stacked
- The Bio-Tec boiler can be installed in vented (open) or unvented (closed) heating systems
- The installer must provide for adequate system expansion in line with relevant engineering and building regulation standards

Accumulation Tank

- A suitably sized accumulation tank MUST be used with the Bio-Tec boiler.
- The recommended sizing is a minimum of 50 litre of per 1kW of boiler output, e.g. a 35kW boiler would require a 1750l tank
- Why
 - When filled a Bio-Tec 35Kw holds between 30Kg and 50Kg of wood (depending on wood type)
 - Energy content of 1Kg of wood = 14.5MJ/Kg = 4kWh/Kg
 - Energy content of 50Kg of wood = 50Kg x 4kWh/Kg = 200kWh
 - 200kWh of inputted energy would heat 2000l of water from 15°C to 85°C (allowing for boiler & system losses)



Optimising Thermal Storage

- Firebird recommend that a Laddomat 21 pump charging system is installed in a Bio-Tec heating circuit to
 - protect the boiler shell from water steam condensate coming from the flue gases, i.e. only allows water > 72 C back into boiler
 - manage charging of the accumulation tank
 - Provide safe heat dissipation in the event of a power failure



Thermal safety valve

- In a closed (unvented) heating circuit installation a thermal safety valve must be fitted to the Bio-Tec boiler. This gives added protection in the unlikely event that the Bio-Tec temperature safety switch does not activate
- The Thermal safety valve (shown right) allows cold mains water to pass through the upper part of the boiler shell if the boiler temperature exceeds 95°C

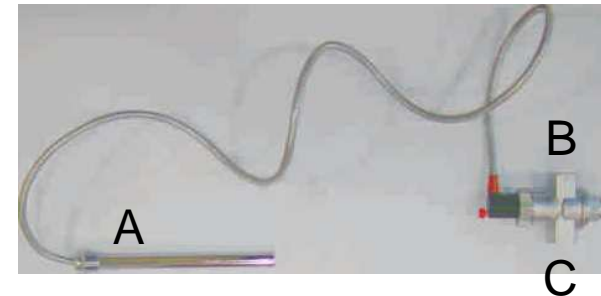

To fit the thermal safety valve:

- insert tube (A) into the middle of the three ½” fittings on the right hand side of the boiler (D)
- Connect the cold mains water to the lower fitting (C) of the Thermal Safety Valve
- Connect the upper side of the Thermal Safety Valve (B) to the ½” fitting nearest the front of the boiler (D)
- Connect the last of the three ½” fittings to a suitable drain outlet



Flues

- **Flue inner diameter and height should be according to the chart on RHS**
 - Minimum inner diameter = 200mm (8")
 - Flue height is measured from the boiler flue outlet to the top of flue
- **Due to the high temperatures flue must be insulated**
- **Flue Draft required = 18 pascals**

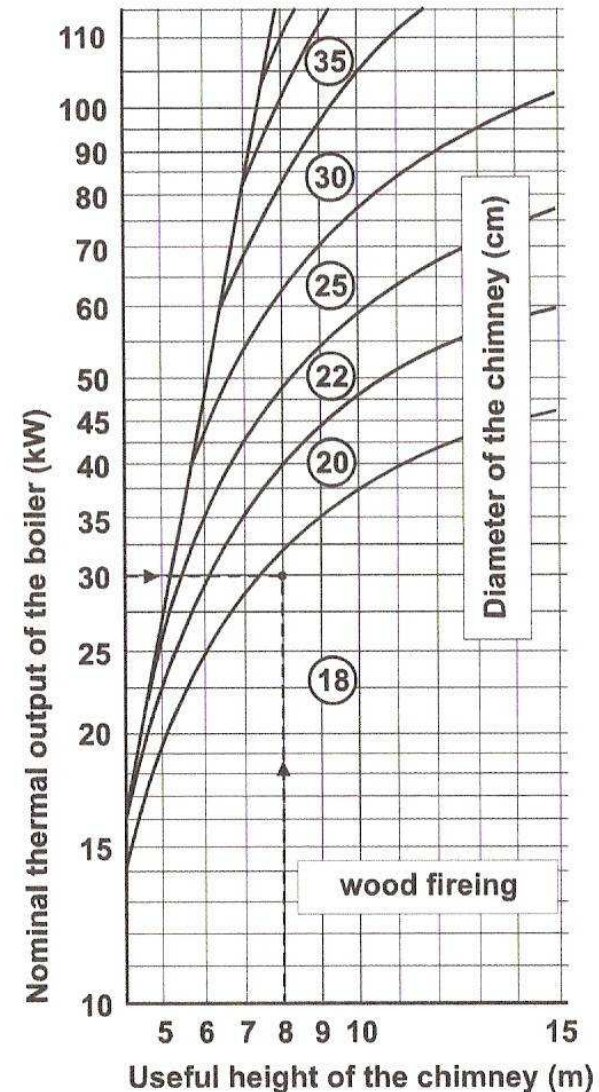

Flues (cont.)

Recommended flue system

- From the flue outlet on the boiler you should ideally start with a 45 degree connection upwards
- Use another 45 degree connection to go vertical
- Insert a T-piece with draft stabiliser
- Observe recommended height per chart

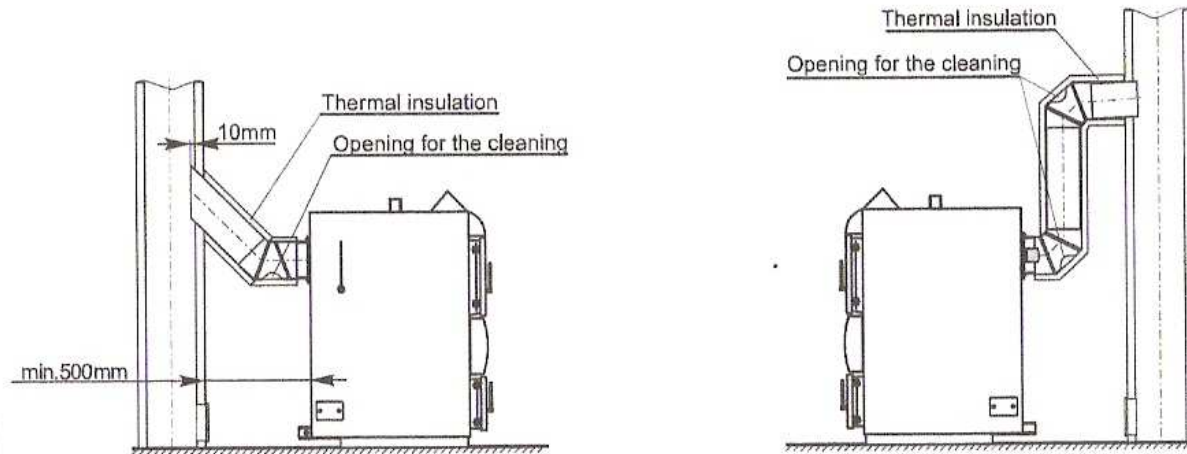

Part V

Installation



Hydraulic Connections

Flow
(1 ½" connection)

Return
(1 ½" connection)

Connections for
thermal safety valve



Electrical Connections

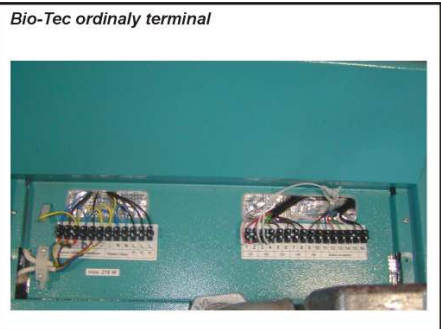
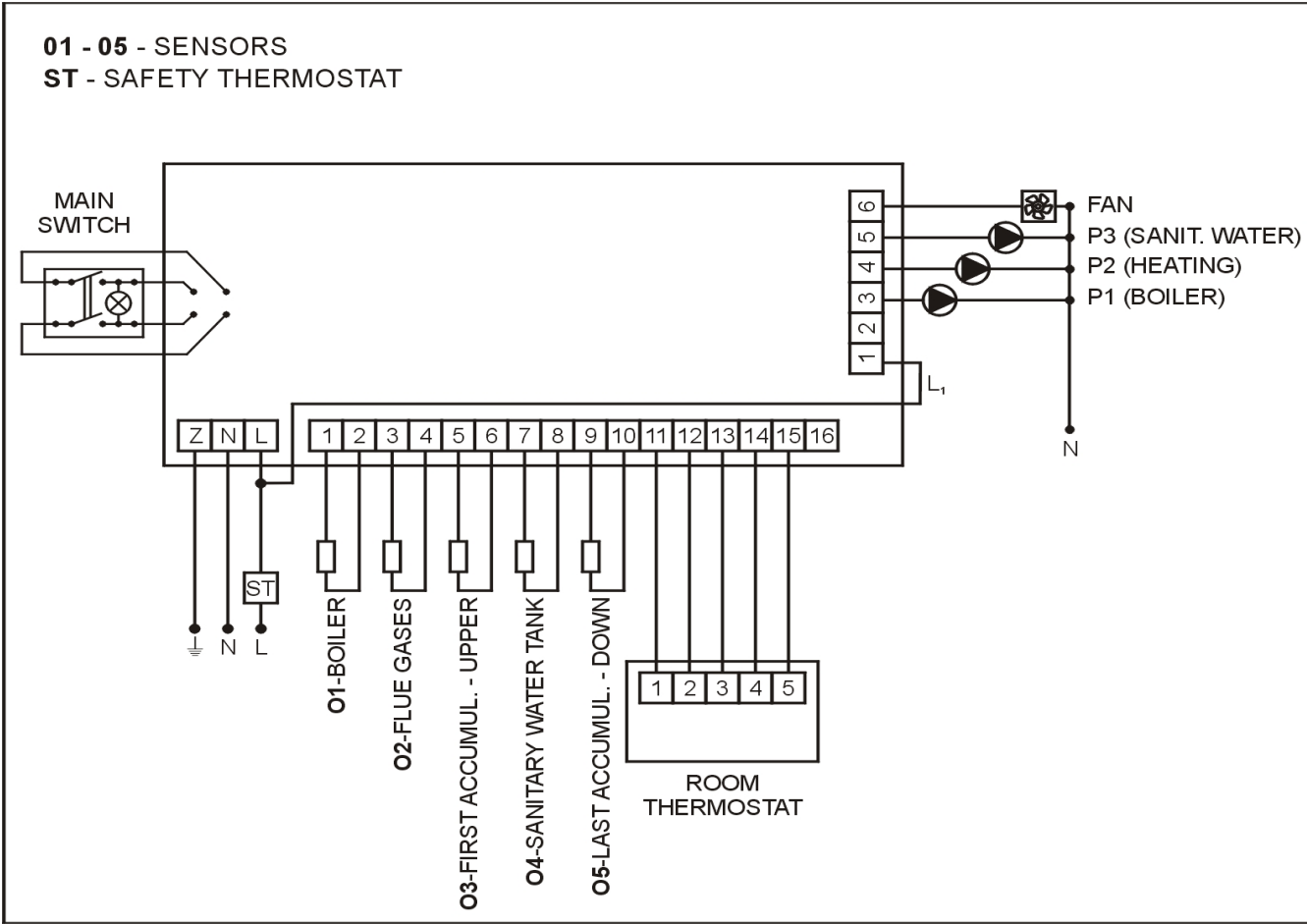

Sensors

3 x NTC 5k/25 and 1 x Pt1000 sensors are supplied with the boiler (O1 is pre-wired in manufacturing)

| No. | Measures | Sensor Type |
|------------|---|--------------------|
| O1 | Boiler Temperature | NTC 5k/25 |
| O2 | Flue Gas Temperature | Pt1000 |
| O3 | Accumulator Tank Upper Temperature | NTC 5k/25 |
| O4 | DHW Tank Temperature | NTC 5k/25 |
| O5 | Reserved for additional accumulator tank | NTC 5k/25 |



Part VI

Commissioning



-
- **Flue gas analysis**
 - **Test run**
 - **Check thermal safety valve**

Part VII

Maintenance



5. Maintenance - Householder

After 24 hours of use OR every week

1. Clean out upper and lower combusting chamber using the cleaning pokers provided.
2. Scrape the ash from the refractory stone using the semi-circular shaped poker

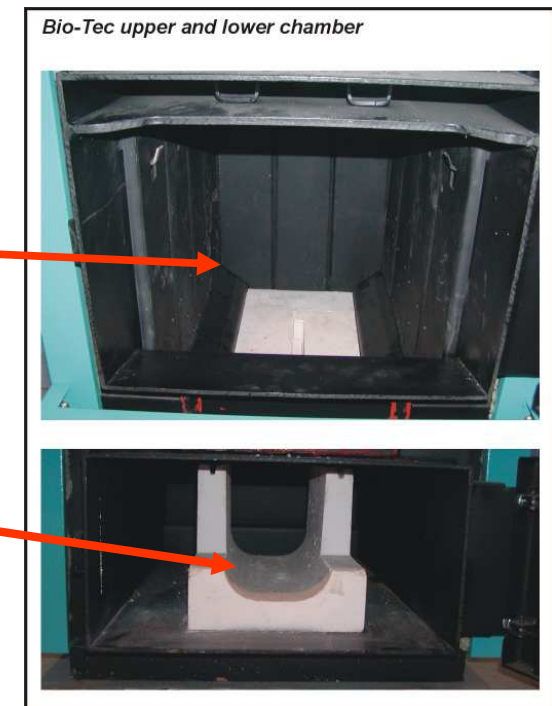

Maintenance - Householder

3. Rotate at the bottom left hand side. This will dislodge ash on the flue gas turbulators



4. Open the small door at the back right hand side of the boiler and remove all ash

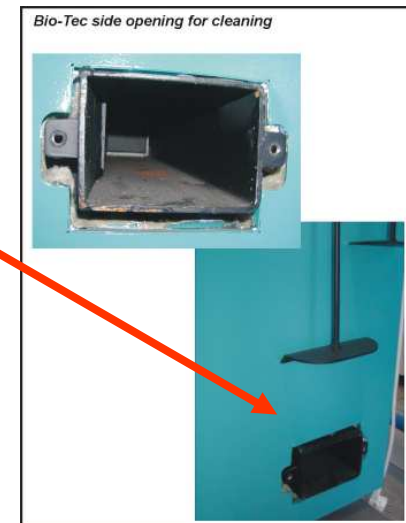

Maintenance – Every 6 Months

- i. **Cleaning the upper and lower chambers and remove all ash and debris. Do NOT remove the refractory stone**
- ii. **Remove the flue extractor fan at the back and clean**
- iii. **Clean the flue gas turbulators at the back of the boiler**
- iv. **Check operation of the safety pressure switch and air vent**

Work must be carried out by an authorised Firebird Service Engineer

